

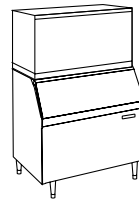

- B 193
- B 350
- B 393
- B 550
- RB 400
- BH 360
- BH 550
- BH 900**
- B 1025
- B 120
- BH1100
- BH1300
- BH1600
- B 3200
- B 4600

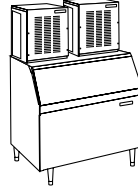

CME1356 on BH900  
(sold separately)



2xFME 1204 on BH900 with KBT25  
(sold separately)

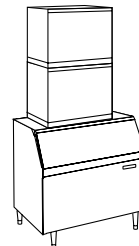

(1 or 2) CME656 on BH900 with KBT22  
(sold separately)

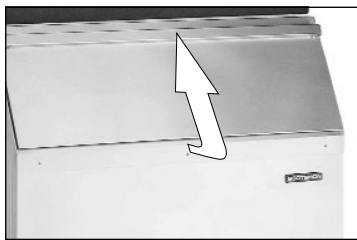
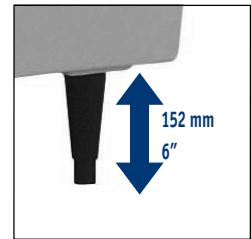

**Ice Storage Bin**

**Cabine de Stockage**

**Eisspeicher**

**Cabina Almacenadora**

**Contentitore Ghiaccio**

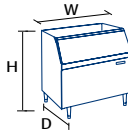
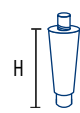
	CONTOUR ICE			FLAKE ICE					
	[kg]	(lbs)	N°**	[kg]	(lbs)	[WxDxH mm]	[WxDxH inches]	[mm]	[inches]
BH 900 S	340	740	30900	290	635	1224 x 857 x 1270	48" x 33" x 50"	152	6"

**Accessories:**

- KBT 24 - Bin top cover when used with MF 41/51 - FME 804/1204 - NME 654
- KBT 22 - Bin top cover when used with CME 656/506
- KBT 25 - Bin top cover when used with 2 x FME 1204/804/NME 654

\*\* Estimate

[www.scotsman-ice.com](http://www.scotsman-ice.com)  
[www.scotsman-ice.it](http://www.scotsman-ice.it)

**2**

**Years Warranty**  
**Ans de Garantie**  
**Jahre Garantie**  
**Años de Garantía**  
**Anni di Garanzia**



Subject to certain limitations and exclusions  
Assujettie aux limites et exclusions prescrites  
Abhängig von Bestimmten Einschränkungen und Ausnahmen  
Sumitido a algunas limitaciones y exclusiones  
Soggetta ad alcune limitazioni ed esclusioni

This product qualifies for the following listings:

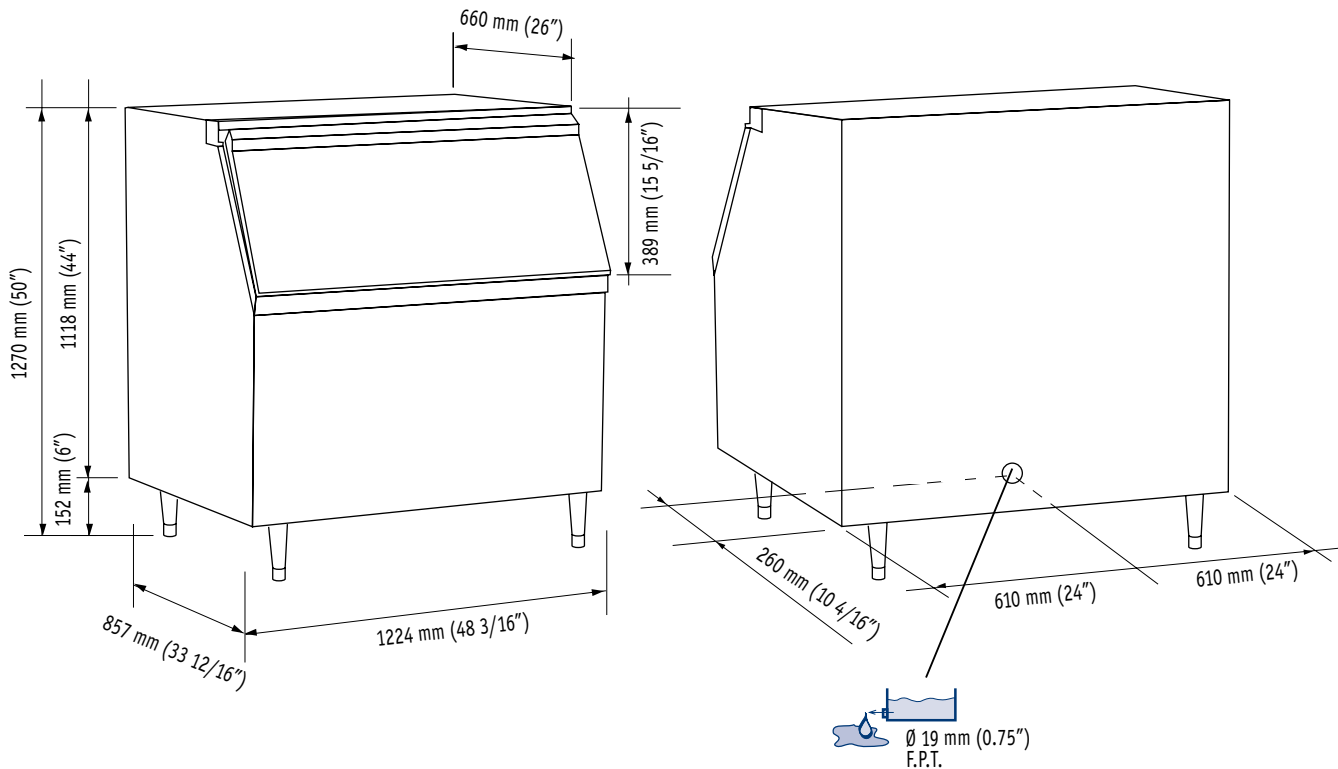

# BH 900



		
	[kg] [lbs]	[kg] [lbs]
BH 900 S	83 182	84 185

The ideal bin is particularly suited for the CME 1356 and CME 1656 and for the MF 41, MF 51, FME 804, FME 1204 and NME 654 modular machines. The liner is in sanitary Polyethylene mounted in one piece without corners and welding points. Polyurethane foam insulation of the cell. The plastic door allows easy access to the stored ice.

#### TOP KBT 22-24-25

Insulated stainless steel top provides cover for bin and base when mounting a modular flaker.

Cabine de stockage particulièrement indiqué pour CME 1356 et 1656, ainsi que pour les machines modulaires MF 41, MF 51, FME 804, FME 1204 et NME 654. La bac intérieure de BH900 est sans angles ni soudures d'une seule pièce en Polyéthylène atoxique pour aliments. l'isolation de la cabine est assurée par du polyurethane expansé. La porte d'accès est en matériel synthétique et permet d'enlever aisément la glace.

#### COUVERCLE KBT 22-24-25

En tôle inox isolé, sert de couvercle pour la cabine et de plan d'appui pour les machines modulaire à glace en grains.

Dieser Speicher ist ideal für die Typen CME 1356 und CME 1656, MF41, MF51, FME804, FME1204 und NME654. Die Speicherzelle ist aus lebensmittelechten Polyethylen in einem Stück gegossen. Die verwendete Isolierung ist aus Polyurethan-Schaum gefertigt. Die aus Kunststoff gefertigte Anthahmeklappe erleichtert die Eisentnahme.

#### ABDECKPLATTE KBT 22-24-25

Die als Zubehör erhältliche Abdeckplatte KBT24 dient als oberer Speicherabschluß und Aufstellfläche für modulare Flockeneisbereiter.

Contenedor ideal y particularmente para los CME 1356 y CME 1656. También se puede utilizar con los modelos MF 41, 51, FME 804, FME 1204 y NME 654. La cuba de la BH900, sin ángulos ni soldaduras está construida de una única estampación en Polyethylene atóxico alimentario. El aislamiento es a base de poliuretano expandido. La puerta, de material sintético permite una fácil recogida del hielo.

#### TAPA KBT 22-24-25

En acero inoxidable, rellena con aislamiento, sirve como cerramiento superior, y de base cuando se monta un módulo de hielo triturado.

Contenitore ideale particolarmente adatto per il CME 1356 e CME 1656 e per i modulari MF 41, MF 51, FME 804, FME 1204 e NME 654. La cella del BH900, senza angoli né saldature, è costituita da un unico stampo in Polietilene atossico per alimenti. La coibentazione della cella è in poliuretano espanso. Lo sportello, in materiale sintetico, permette un comodo prelievo del ghiaccio.

#### COPERCHIO KBT 22-24-25

In acciaio inossidabile protetto con isolamento, serve come coperchio e da base quando si monta un modulare granulare.



**Scotsman**<sup>®</sup>  
Ice Systems

The one the world relies on.

Certified ISO 9001:2000

#### USA, Canada, Latin America

Scotsman Ice Systems USA  
775 Corporate Woods Parkway  
Vernon Hills, IL 60061  
Ph: (847) 215-4550  
Fax (847) 913-9844  
customer.service@scotsman-ice.com

#### Europe

Scotsman Europe-Frimont S.p.A.  
Via Puccini, 22  
20010 Pogliano (Milano) Italy  
Ph: (+39) 02-93960208  
Fax: (+39) 02-93960201  
scotsman.europe@frimont.it

#### Asia and Pacific

Scotsman Ice Systems-Frimont S.p.A. (R.O.)  
627A Aljunied Road-#04-04 Biztech Centre  
Singapore 389842  
Ph: (+65) 6738 5393  
Fax: (+65) 6738 1959  
scotsice@singnet.com.sg

#### China

Scotsman Ice Systems  
258 Tong Ren Road Golden Tower 7A  
Shanghai-200040 Peoples's Republic of China  
Ph: (+86) 21-62476056  
Fax: (+86) 21-62476126  
scotsmansh@online.sh.cn

#### Middle East & N. Africa

Scotsman Ice Systems Dubai Office  
P.o. Box 13205 - Deira  
Dubai - U.A.E.  
Ph: +9716-5654036  
Fax +9716-5654063  
scotsman@emirates.net.ae

#### South Africa

Scotsman Ice Systems SA (PTY) Ltd.  
10, Rhodes Street - Kensington B  
P.o. Box 44 - Riverclub 2149  
Ph: +27-11-7898400  
Fax +27-11-7898411  
scotsman@telkomsa.net