

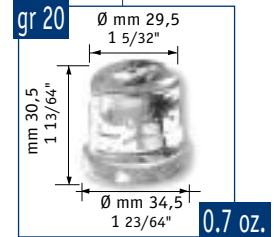

- ACM 25
- AC 45
- AC 55
- AC 85
- AC 105
- AC 125
- AC 175
- AC 225

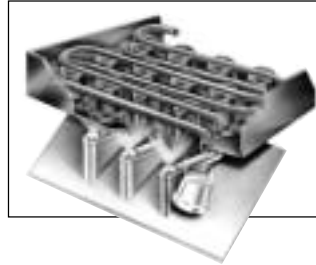

**GOURMET ICE CUBE**

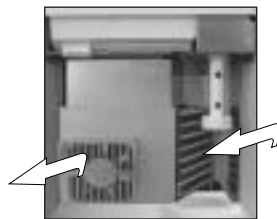
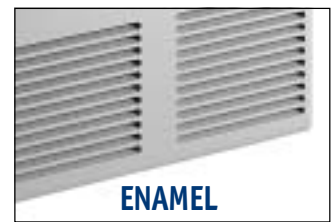
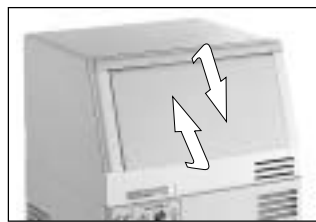

Additional Air Extractor Fan

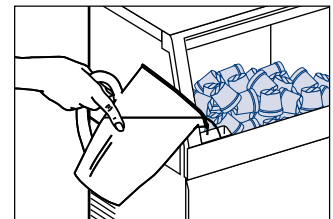
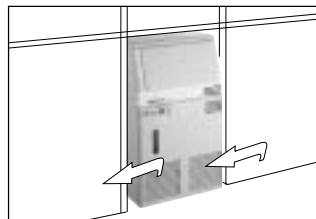

**Automatic  
Gourmet-Cube  
Ice Maker**

**Machine  
Automatique  
à Glaçons  
Gourmet**

**Automatischer  
Gourmetkegel-  
eisbereiter**

**Màquina  
Automàtica  
Fabricadora  
de Cubitos  
Gourmet**

**Produttore  
Automatico  
di Ghiaccio  
a Cubetti  
Gourmet**

		10° : 10°C			21° : 15°C									
AC M 25 AE		[kg]	[lbs]	N°*	[kg]	[lbs]	N°*	[kg]	[lbs]	N°*	[v/Hz/ph]	[WxDxH mm]	[WxDxH inches]	R 134 a
		10	22	500	9	20	450	3,5	7,7	175	230/50/1	380x380x640	14"x14"x25"	

\*Estimated number of medium size cubes  
Available at 230/60/1 also

[www.scotsman-ice.com](http://www.scotsman-ice.com)  
[www.scotsman-ice.it](http://www.scotsman-ice.it)

**2**

Years Warranty  
Ans de Garantie  
Jahre Garantie  
Años de Garantía  
Anni di Garanzia

Subject to certain limitations and exclusions  
Assujettie aux limites et exclusions prescrites  
Abhängig von Bestimmten Einschränkungen und Ausnahmen  
Sujeta a algunas limitaciones y exclusiones  
Soggetta ad alcune limitazioni ed esclusioni



This product qualifies for the following listings:



# ACM 25

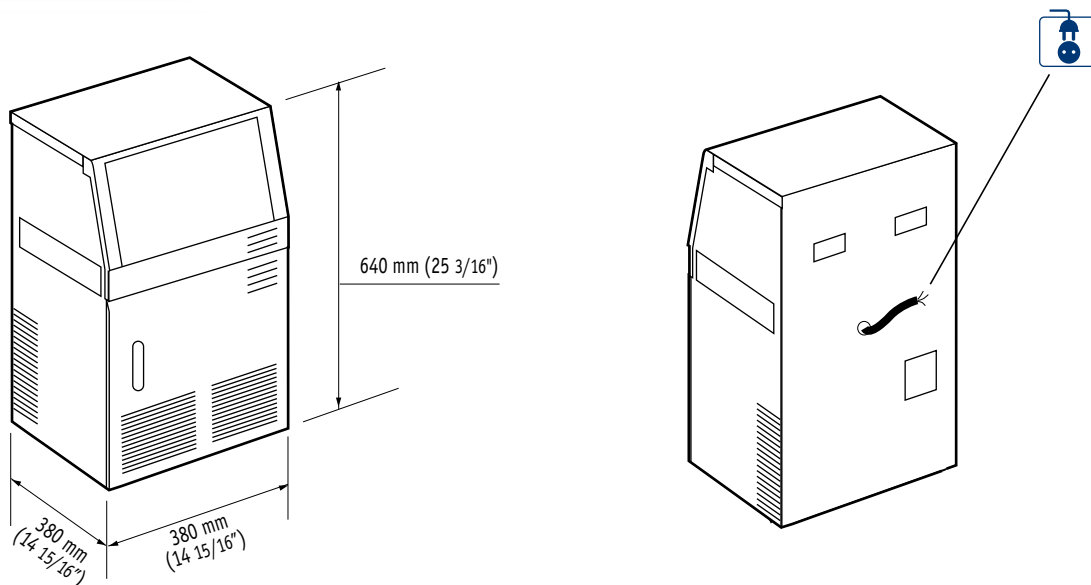

AC M 25 AE		[Btu/h] [W]	[Ømm <sup>2</sup> ]	[W]	FUSE [A]	[kWh] 24h	[L] [gal]	[kg] [lbs]
		2250 660	3x1	250	10	5.5	5.5 1.5	30 66 33 72

## ACM 25 AIR COOLED



10°C	10	kg
50°F	22	lbs
21°C	9	kg
70°F	20	lbs
32°C	6.5	kg
90°F	14	lbs
38°C	5	kg
100°F	11	lbs



<b>Minimum</b>		<b>Maximum</b>
10°C (50°F)		35°C (95°F)
5°C (41°F)		35°C (95°F)
-10%		+10%

NOTE: when machine is built in at ambient temperature of 32°C (90°F) indicated ice capacity decreases about 10%

Machine requires voltage indicated on rating name plate. Failures caused by improper voltage are not considered factory defects. Scotsman products are not designed for outdoor installation. Extended periods of operation at temperatures exceeding the above limitations constitutes misuse under the terms of Scotsman Limited Warranty, resulting in a loss.

La machine doit être raccordée conformément au voltage indiqué sur la plaque signalétique. Les éventuels dégâts causés par un non respect de cette consigne ne peuvent être considérés comme des défauts de fabrication. Les machines à glace Scotsman ne sont pas conçues pour être utilisées à l'extérieur. Le fonctionnement prolongé à des températures supérieures ou inférieures aux limites ci-dessus sont considérées comme une mauvaise utilisation dans le cadre de la garantie Scotsman.

Der Eisbereiter benötigt eine Stromspannung gemäß Geräte-Typenschild. Störungen oder Ausfälle, durch den Betrieb mit falscher Stromspannung sind keine Fabrikationsfehler und fallen nicht unter Garantie. Scotsman Eisbereiter sind nicht für die Installation im Freien geeignet. Der längere Betrieb bei Temperaturen über den obigen Grenzwerten ist eine falsche Anwendung und bedeutet den Verlust der Garantieleistung.

Los requerimientos eléctricos de la máquina están indicados en la placa de características. Los daños causados por voltajes inadecuados no son considerados defectos de fábrica. La máquinas de hielo Scotsman, no están diseñadas para trabajar a la intemperie. Largos periodos de funcionamiento a temperaturas que excedan de las limitaciones indicadas, constituyen maltrato de acuerdo con las observaciones de Scotsman.

La macchina richiede il voltaggio indicato sulla targhetta di identificazione. Danni causati da voltaggi diversi non sono considerati difetti di produzione. I prodotti Scotsman non vanno utilizzati all'aperto. Un prolungato periodo di utilizzo al di fuori delle temperature indicate non è consentito e causa l'automatico decadere della garanzia.



**Scotsman**<sup>®</sup>  
Ice Systems

The one the world relies on.

Certified ISO 9001:2000

### USA, Canada, Latin America

Scotsman Ice Systems USA  
775 Corporate Woods Parkway  
Vernon Hills, IL 60061  
Ph: (+1) 847 215-4550  
Fax (+1) 847 913-9844  
customer.service@scotsman-ice.com

### Europe

Scotsman Europe-Frimont S.p.A.  
Via Puccini, 22  
20010 Pogliano (Milano) Italy  
Ph: (+39) 02-93960208  
Fax: (+39) 02-93960201  
scotsman.europe@frimont.it

### Asia and Pacific

Scotsman Ice Systems-Frimont S.p.A. (R.O.)  
627A Aljunied Road #04-04 Biztech Centre  
Singapore 389842  
Ph: (+65) 6738 5393  
Fax: (+65) 6738 1959  
scotsice@singnet.com.sg

### China

Scotsman Ice Systems  
258 Tong Ren Road Golden Tower 7A  
Shanghai-200040 Peoples's Republic of China  
Ph: (+86) 21-62476056  
Fax: (+86) 21-62476126  
scotsmarsh@online.sh.cn

### Middle East & N. Africa

Scotsman Ice Systems Dubai Office  
P.o. Box 13205 - Deira  
Dubai - U.A.E.  
Mobile: Ph: (+971) 505505980  
Fax (+971) 6-5654063  
scotsman@emirates.net.ae

### South Africa

Scotsman Ice Systems SA (PTY) Ltd.  
10, Rhodes Street - Kensington B  
P.o. Box 44 - Riverclub 2149  
Ph: (+27) 11-7898400  
Fax (+27) 11-7898411  
scotsman@telkomsa.net